

# Label printer



**model STE 104**



# STE 104 Label printer

## Technical specifications

- RESOLUTION
- 203 dpi/8 dots per mm
- PRINT SPEED
- Maximum print speed 5"/127 mm per second
- MAXIMUM PRINT AREA
- Width: 4.09"/104 mm
- Length: 39"/991 mm
- MEDIA SPECIFICATIONS
- Label and liner width: 0.75"/19 mm to 4.25"/108 mm
- Ribbon width: 1.33"/33.8 mm to 4.3"/109.2 mm
- Ribbon length: 244'/74 m
- MEMORY
- 8 MB SDRAM
- 4 MB Flash
- CONNECTIVITY
- Serial RS-232
- USB V1.1
- Dimension: 194(L)x191(P)x254(A) mm
- Weight: 2,1 kg

## Main features

- Thermal transfer printer, easy to use and easy to load the ribbon
- Allows producing clear prints and labels with a long-lasting image.
- Suitable for any sector, it provides optimal printing speeds and connectivity options

*The above mentioned features are characteristics of the printer, which will be dimensioned case by case to suit the associated electronic weight indicator.*

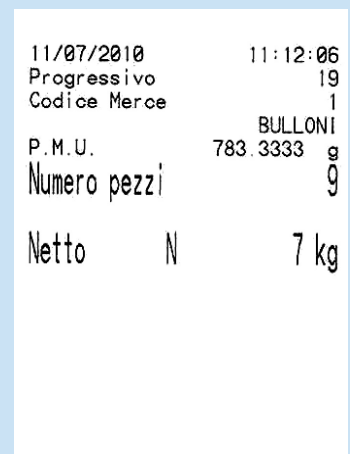
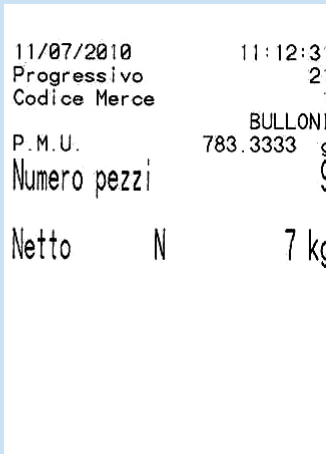
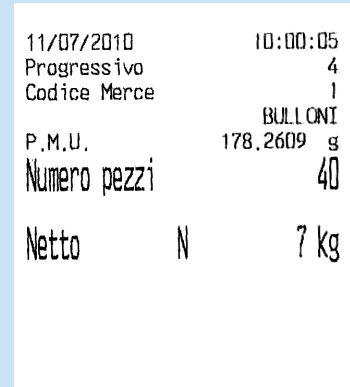
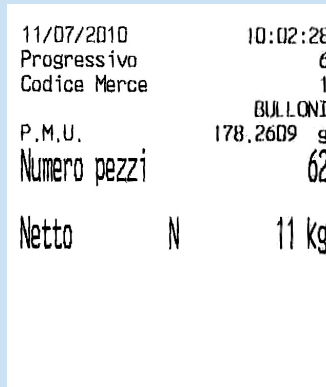
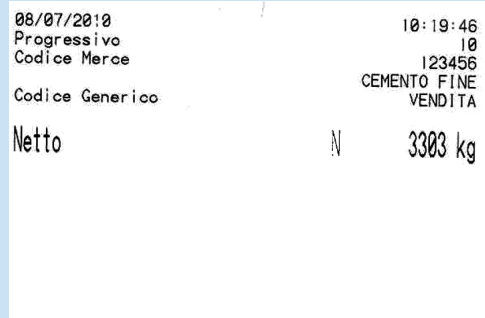
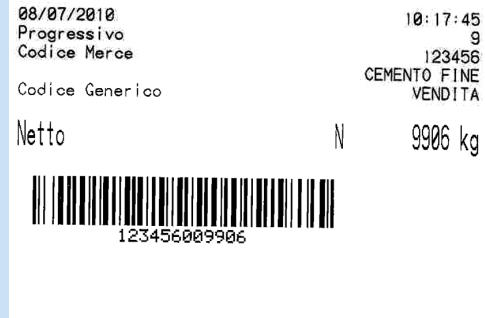
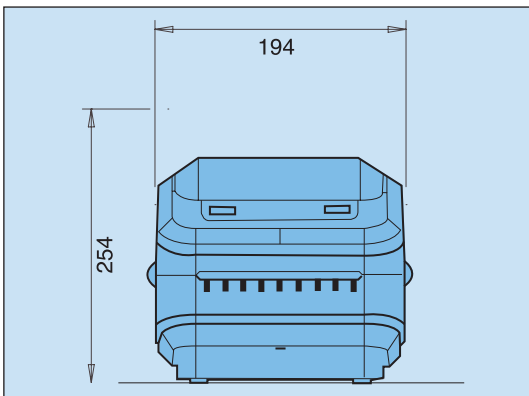

Print examples



Società Cooperativa Bilanciai Campogalliano  
 41011 Campogalliano (MO) Italy - Via S. Ferrari, 16  
 Tel. +39 059 / 89.36.11 - Fax +39 059 / 52.70.79  
[www.coopbilanciai.it](http://www.coopbilanciai.it) - [cb@coopbilanciai.it](mailto:cb@coopbilanciai.it)

Agent / Dealer